

DECORATIVE ELEMENTS



Add a little flare to your glass structure.

The following pages provide customers with an overview of the decorative options available through Solar Innovations®. Although we are able to create custom castings to meet the specifications of each structure, these standard finials, appliques, corners, grids, pediments, trim, and gutter options are available as economical options for our customers.

Adding decorative aluminum castings and extrusions enhances the visual and architectural appeal of many applications. They are often incorporated to create a unique focal point or to blend with existing surroundings. Solar Innovations® offers numerous standard decorative elements and will create custom elements for specific projects.

Solar Innovations® customers can choose from numerous standard colors including White, Bronze, Hartford Green, Natural Clay, Black, Sandstone, and Mill finish aluminum. Clear Anodized, Dark Bronze Anodized, and custom color finishes are available for an additional charge. We also offer a large selection of glazing options, including some of the highest performance combinations available in the market today.

OPTIONS

- Ridge Cresting
- Finials
- Lightning Protection
- Corners/Eave Spandrels
- Appliqués
- SDL's, Grids, & Interior Muntins
- Grids
- Transom Grids
- Gable Pediments
- Corner Post Details
- Ridge Crest Mount
- Ring & Collar Ties
- Trim Options
- Utilizing Decorative Applications
- Gutter Options

RIDGE CRESTING



Cresting CA 000054-00-00
Height 5 3/4" | Length 14"



Cresting CA 000066-00-00
Height 5 1/4" | Length 31 1/8"



Cresting CA 000007-00-00
Height 8 1/8" | Length 31 1/2"



Cresting CA 000059-00-00
Height 9 1/2" | Length 14 3/4"



Cresting CA 000005-00-00
Height 9 3/4" | Length 34"

DECORATIVE FINIALS



7" Fleur-De-Lys
CA 000044-00-00
Height 7"
Width 3 1/4"



9 1/4" Fleur-De-Lys
CA 000015-00-00
Height 9 1/4"
Width 5 5/8"



**7" Fleur-De-Lys
with Curve**
CA 000012-00-00
Height 7"
Width 3 3/4"



10 3/4" Spire
CA 000055-00-00
10 3/4" Height



6 5/8" Fleur-De-Lys
CA 000017-00-00
Height 6 5/8"
Width 3 7/8"



7 1/2" Fleur-De-Lys
CA 000078-00-00
Height 7 1/2"
Width 3 3/4"



8 1/2" Fleur-De-Lys
CA 000073-00-00
Height 8 1/2"
Width 3 3/4"



6 1/2" Base Plate
CA 000061-00-00
6 1/2" Diameter



4 3/16" Ball Finial
CA 000050-00-00
4 3/16" Diameter



Bell Cap
CA 000051-00-00
Height 4"
Width 4 1/4"



**25 1/2" Double
Ball & Spire**

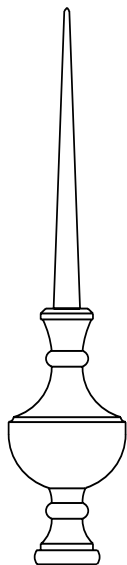

**27" Ball &
Spire**

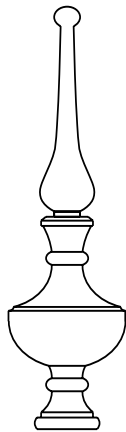

**21" Ball &
Spire**

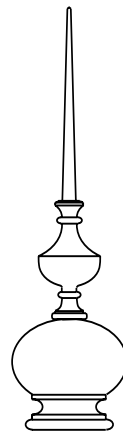

**20 1/4" Double
Ball & Spire**

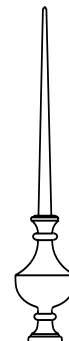

**16" Ball &
Spire**

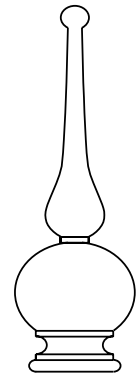

**15 1/2" Ball &
Spire**

LIGHTNING PROTECTION

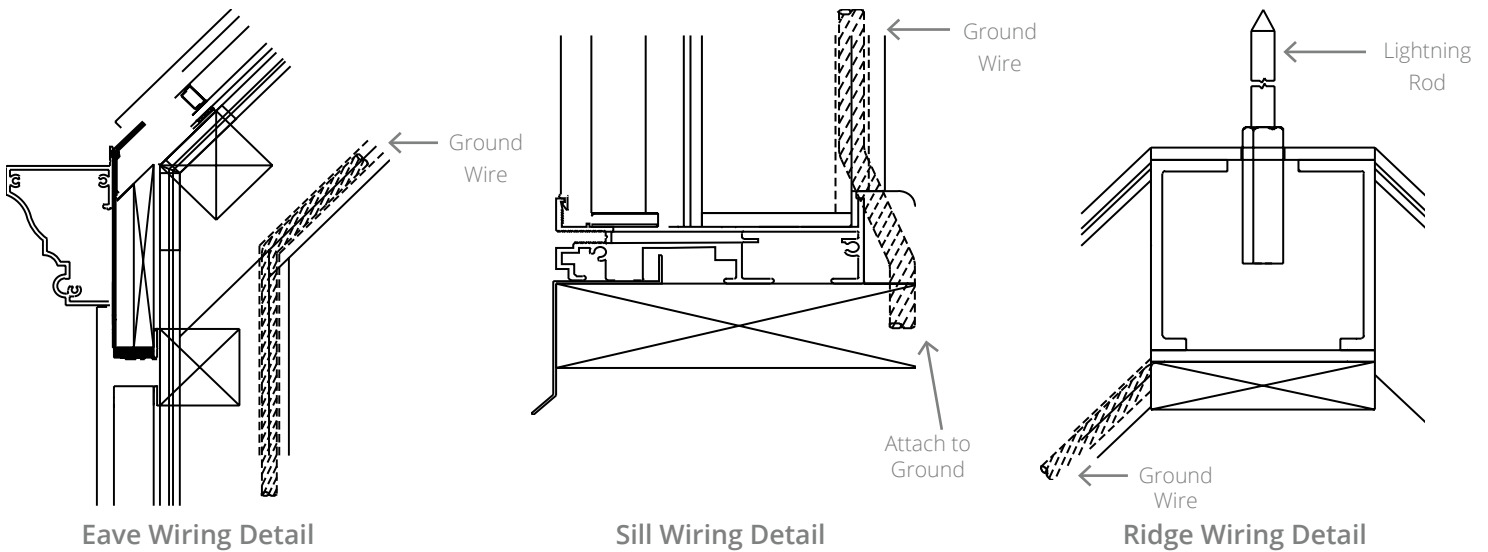

Lightning protection can be utilized in an aluminum or wood system. Most finials, with at least a minimum thickness of 3/16", can be a lightning rod. Solar Innovations® recommends a full lightning protection system for all structures. Therefore, customers should bond the metal structure to its own earth-ground or tie it directly to an existing building's grounding system.

Lightning protection is a subject often misunderstood in the construction industry. It may require a subjective decision based on an examination of the relative critical nature of the structure's location and its contents. Architects and engineers take site specific lightning flash density into consideration to determine the lightning protection.

Details subject to change depending on application.

DECORATIVE CORNERS



Corner CA 000001-00-00
Height: 17"
Length: 17"

Eave spandrels, or decorative corners, can be considered one of the oldest forms of decorative architecture and can be found in buildings as early as ancient Rome. An eave spandrel was historically the space between an arch and a wall or column, but can also occupy the space between a wall and a squared-off opening. While eave spandrels are primarily decorative, they can also be used for shelf supports or plant hangers.

DECORATIVE APPLIQUÉS



3 1/4" Appliqué
CA 000028-00-00
Diameter 3 1/4"



2 5/8" Appliqué
CA 000035-00-00
2 5/8" Diameter



7" Appliqué
CA 000027-00-00
Height 7"
Width 5 1/2"



3 3/4" Appliqué
CA 000023-00-00
Diameter 3 3/4"



4 3/8" Appliqué
CA 000033-00-00
Height 4 3/8"
Width 3 1/4"

Decorative appliqués may be added to each side of the ring in a ring and collar for additional ornamentation.

SDL'S, GRIDS, & INTERIOR MUNTINS

Decorative grids enhance the look of any conservatory. Grids are available in three standard types: Ogee, Traditional, and Colonial. These designs can be used in any of the wall glass including: standard bays, fixed and operable windows, doors, folding glass walls and windows, sliding glass doors and windows, and transom bays. SDLs, grids, and interior muntins can not be applied to curved eave units and sloped glazing. They must be applied to vertical flat glazing.

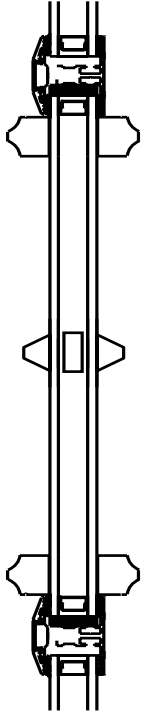

Standard Bay with
SDLs & Grids

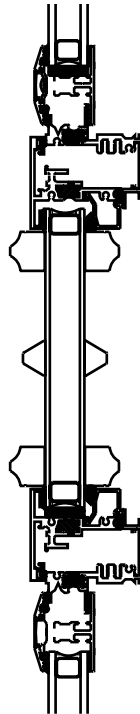

Fixed Window with
Grids

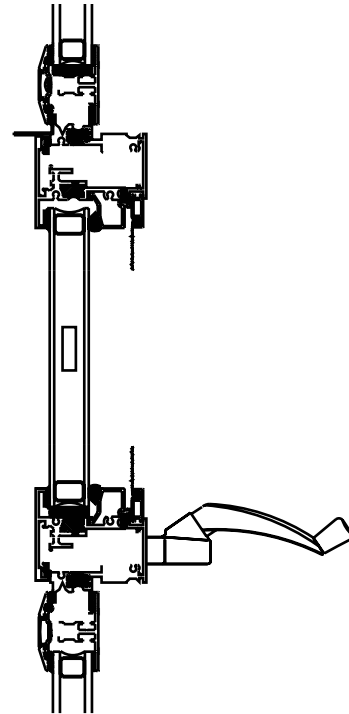

Operable Window with
Interior Muntins

1. Simulated divided lites (SDLs) use exterior trim and an interior aluminum bar to “simulate” a true division.
2. Exterior grids use exterior trim only to give the appearance of divided lites, but the space between the glass is visible when viewed closely.
3. Interior muntins also provide the look of a divided lite from a distance, and they are the easiest to clean, but the space between the glass and the muntin is visible when viewed closely.
4. Exterior grids can be used on single pane applications.

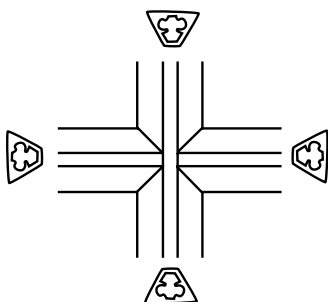

Traditional Grid
Intersection

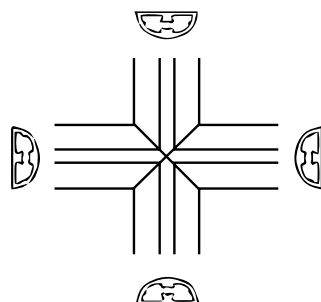

Colonial Grid
Intersection

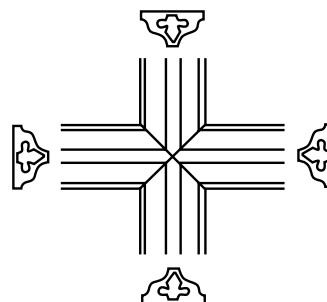

Ogee Grid Intersection

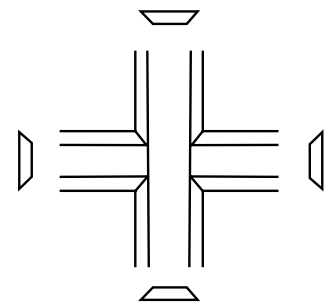

Low Profile
Grid Intersection

DECORATIVE GRIDS

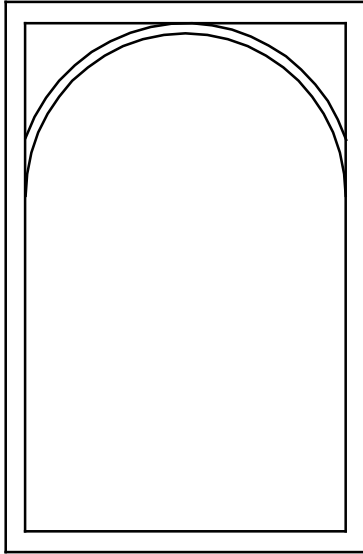

Radius Grid

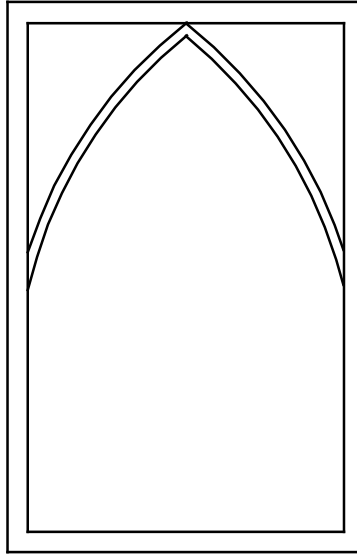

Gothic Grid

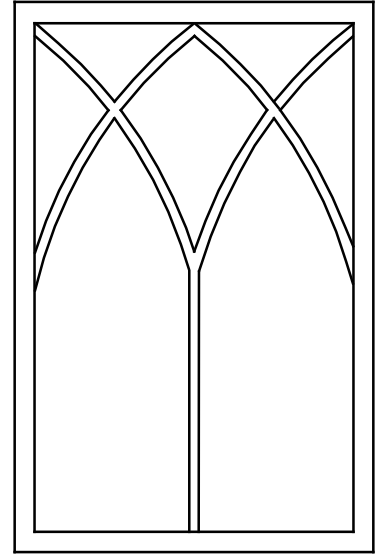

Double Gothic Grid

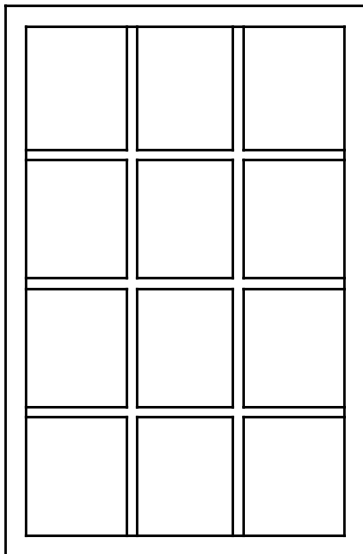

Traditional Grid

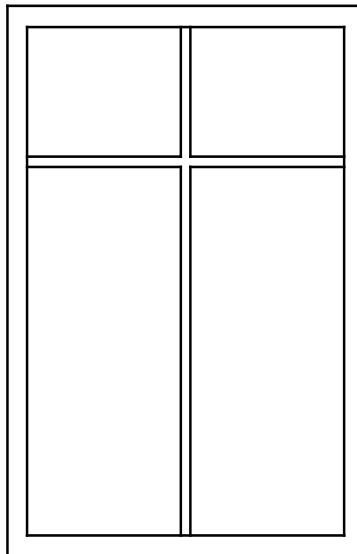

Cross Grid

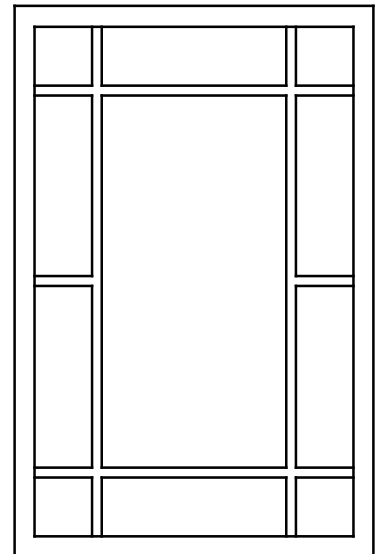

English Grid

PLEASE NOTE

Grids can not be applied to curved eave units and sloped glazing; vertical glazing only..

DECORATIVE TRANSOM GRIDS

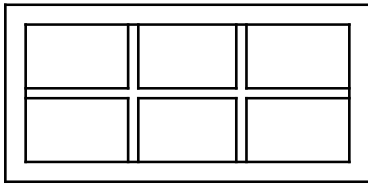

Traditional Transom Grid

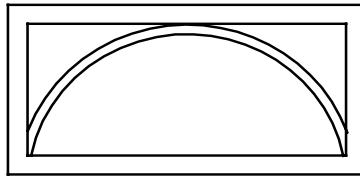

Radius Transom Grid

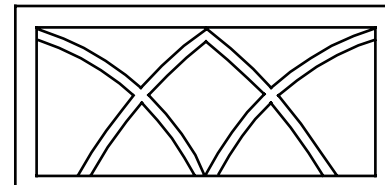

Double Gothic Transom Grid

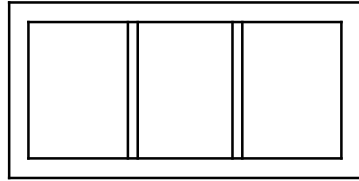

Double Divided Transom Grid

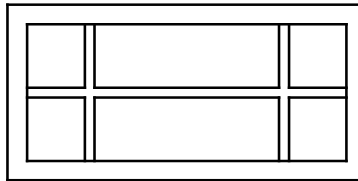

English Transom Grid

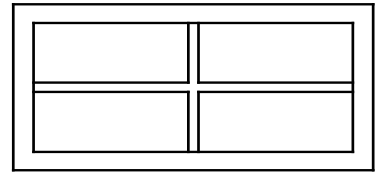

Cross Transom Grid

Use decorative panels to enhance the appearance of your windows, doors, and wall glass. Sliding doors accept only low profile panels.

The panel consists of an aluminum shell (which may be painted to match the frame) and a layer of polystyrene insulation.

The trim is the same grid material used in the window options.

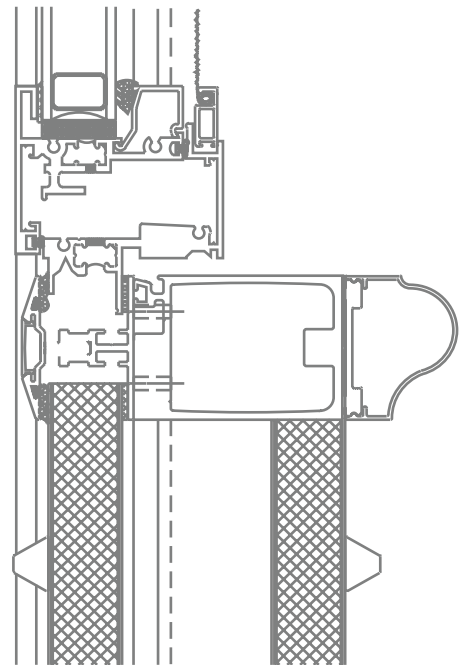

Insulated Panel Base wall with Exterior and Interior Grid

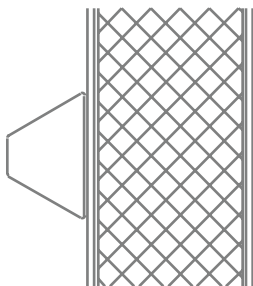

Exterior Grid Panel

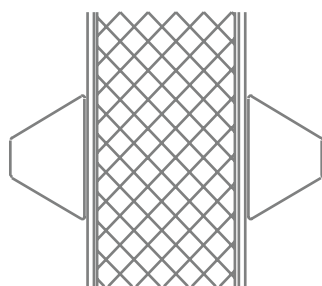

Exterior & Interior Grid Panel



DECORATIVE TRANSOM OPTIONS

Standard Patterns

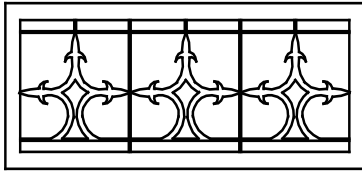

Pattern "A"
Available in Etch or V-Groove

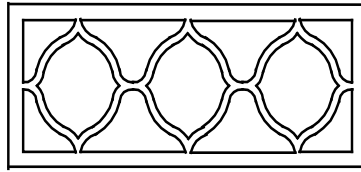

Pattern "B"
Available in Etch or V-Groove

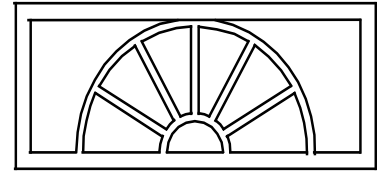

Pattern "C"
Available in Etch, Applied Lead, Applied Grids, or V-Groove

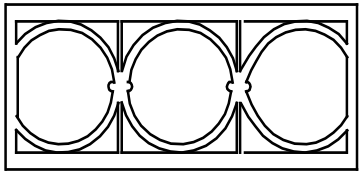

Pattern "D"
Available in Etch or V-Groove

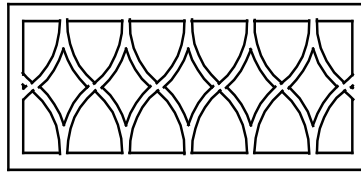

Pattern "E"
Available in Etch or V-Groove

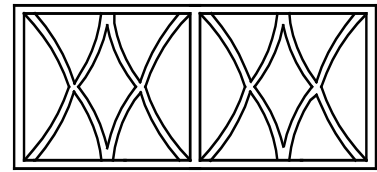

Pattern "F"
Available in Etch, Applied Grids, or V-Groove

Special Order Patterns

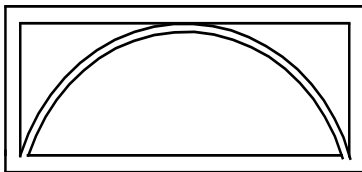

Pattern "G"
Available in Etch, Applied Lead, Applied Grids, or V-Groove

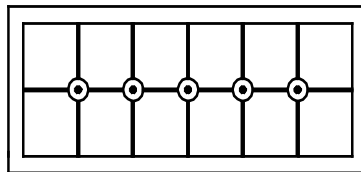

Pattern "H"
Available in Etch or V-Groove

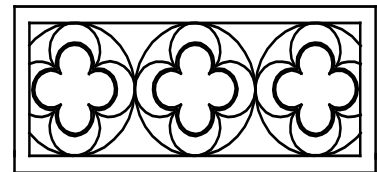

Pattern "I"
Available in Etch or V-Groove

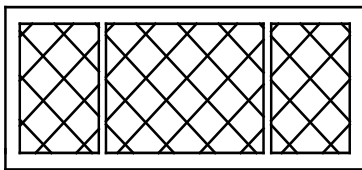

Pattern "J"
Available in Etch, Applied Lead, or V-Groove

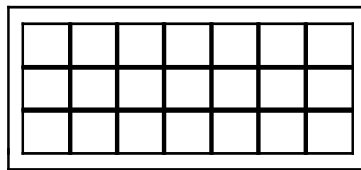

Pattern "K"
Available in Etch, Applied Lead, or V-Groove

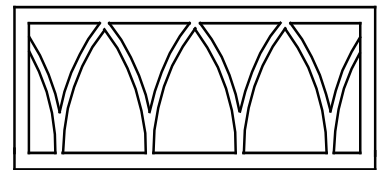

Pattern "L"
Available in Etch, Applied Lead, Applied Grids, or V-Groove

Almost all options shown are available in leaded glass. Custom etching and leaded patterns available upon request.

DECORATIVE GABLE PEDIMENTS

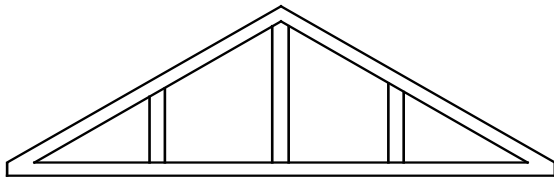

Traditional Gable End

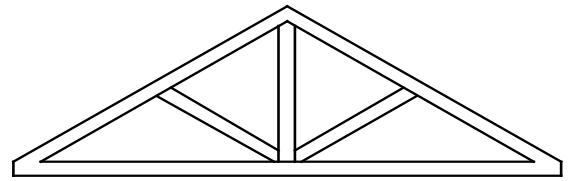

Straight Fan Light

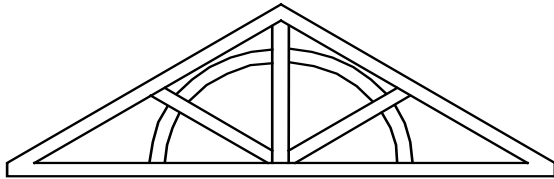

Arched Fan Light Option 1

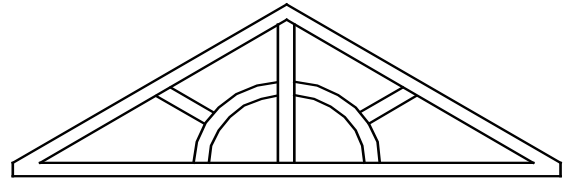

Arched Fan Light Option 2

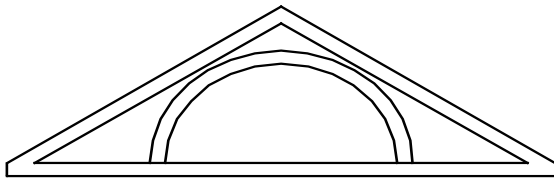

Open Radius Gable End

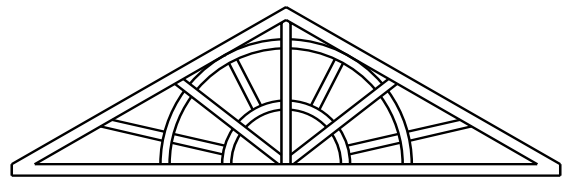

Arched Fan Light Option 3

CORNER POST DETAILS

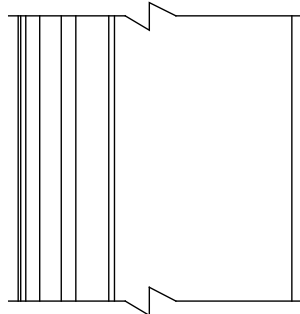
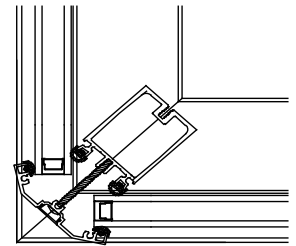

Standard

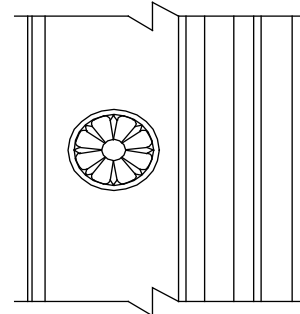
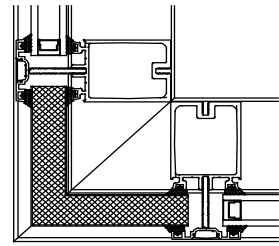

Decorative

Our standard corner detail is used with hip end and conservatory structures. A decorative corner detail can be used instead of our standard corner detail for a more ornamental look. In addition, a decorative appliqué may be added for more ornamentation.

RIDGE CREST MOUNT

Ridge cresting mounts are used as platforms for our ridge cresting. They provide an easy attachment point on the ridge and also clearance for ridge vents.

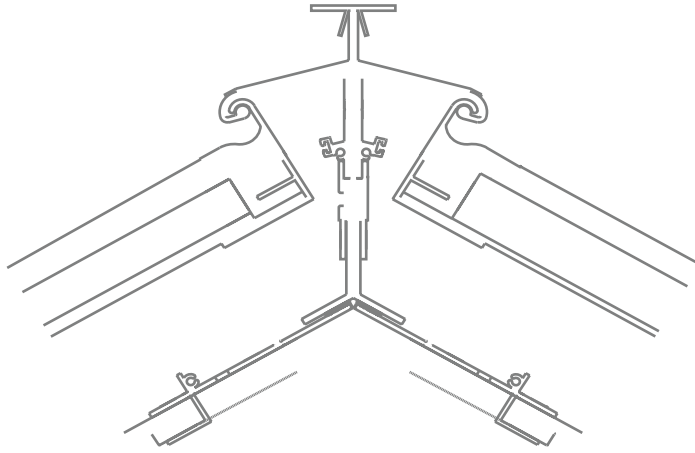

With Ridge Vents

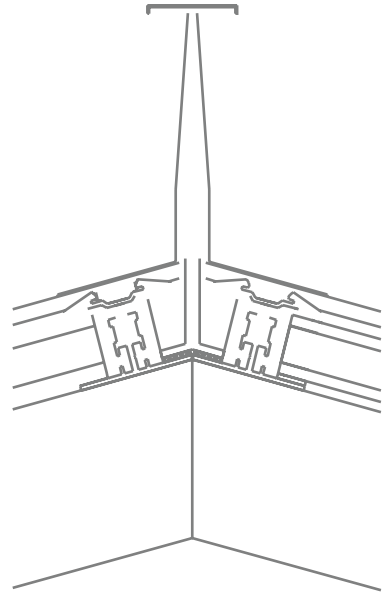

Without Ridge Vents

DECORATIVE RING & COLLAR TIES

The ring and collar tie serves as a structural brace and cross tie for larger structures or free standing structures. Decorative appliques can be added to each side of the ring for additional interest.

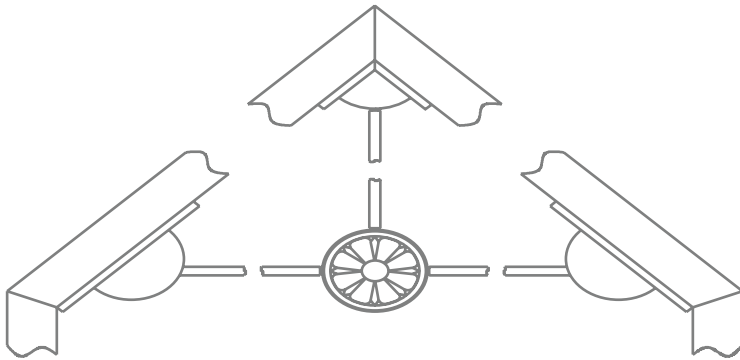

Cross Tie

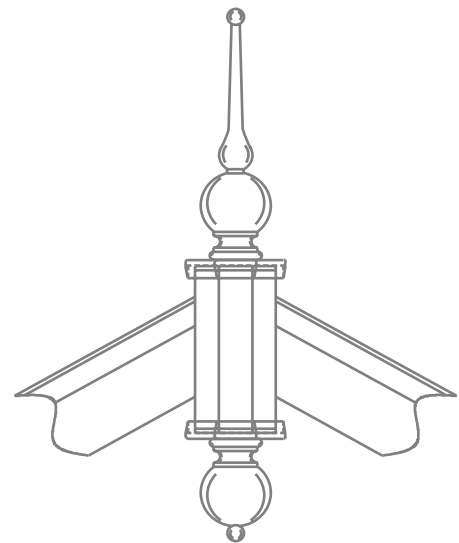

King Post

DECORATIVE TRIM OPTIONS

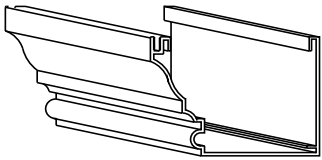

Extruded Gutter and Eave Cornice

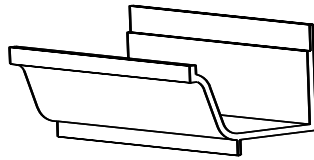

Restoration Gutter

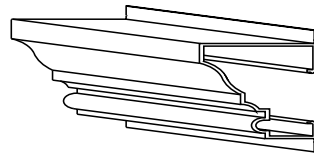

Extruded Gable Rake Crown Molding

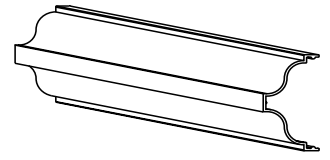

Double Ogee Frame Profile

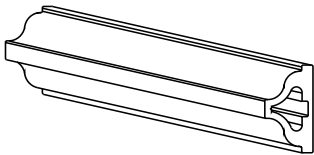

Ogee Grid

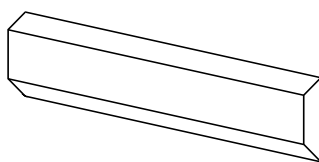

Low Profile Grid

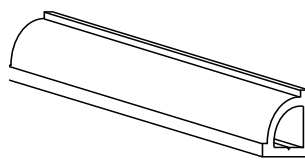

Inside Corner Trim

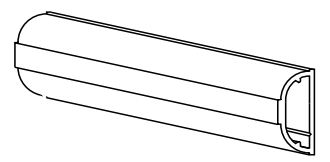

Colonial Grid

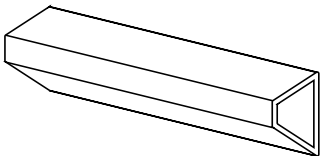

Traditional Grid

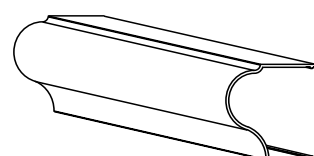

2" Bull Nose Sill & Plate Extension

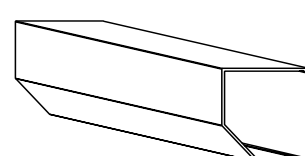

Beveled Nose Sill & Plate Extension

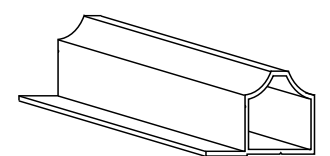

Flanged Sash Molding Muntin Frame

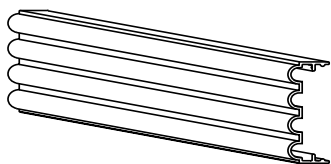

Large or Small Fluted Cap

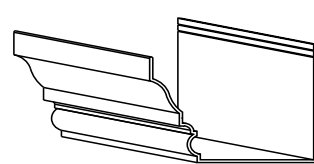

Extruded Gutter Splice

PLEASE NOTE

All of the trim options can be used internally or externally, depending on the application.

GUTTER OPTIONS



Exterior Ogee
Gutter Splice



Restoration Gutter



Box Gutter



Extruded Gutter End Cap



Restoration Gutter
End Cap



Box Gutter
End Cap

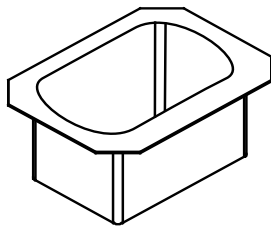

2" X 3" Round
Drop Out*

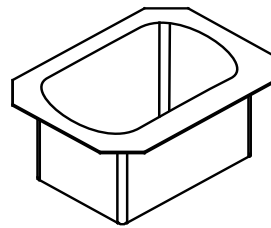

2" X 3" Round
Drop Out*

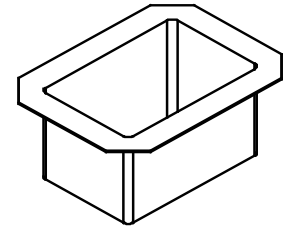

2" X 3" Standard
Drop Out*

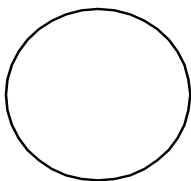

2 ½" Round Downspout
(Smooth)

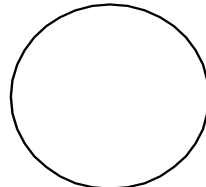

3" Round Downspout
(Smooth)*



2" x 3" Rectangle Gutter
Downspout

* Available in Copper - Note: Not to Scale

ADDITIONAL OPTIONS

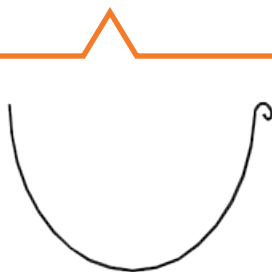

Aluminum Half
Round Gutter



Standard
2 ½" Elbow Style

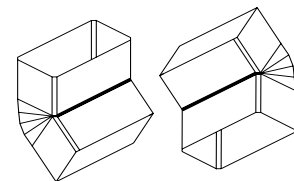

Optional
Box Gutter Drop Out

UTILIZING DECORATIVE APPLICATIONS

Finials



Ridge Cresting



Ridge Vent



Gutter & Molding



Decorative Transom



Grids & SDL



Base Panels



Gable Pediment

